

INT[®]280-60 Diagnose



INT280-60 Diagnose

Illustration similar. Scope of deliver may deviate.

Application

The INT280-60 Diagnose is a further development of the reliable KRIWAN oil level regulators.

The oil level regulator INT280-60 Diagnose monitors and controls the oil level in the refrigerant compressors. The problem of poor oil distribution in multicompressor packs has been overcome by actively supplying oil from the oil reservoir. This minimizes the risk of operating without enough oil in the compressor.

The INT280-60 Diagnose saves operating and error data in a non-volatile memory. This data can be read and evaluated for diagnosis.

Functional description

If the oil level is too low, the intelligent filling algorithm controls the oil refill. To do this, the integrated solenoid valve is opened cyclically.

The oil level regulator switches the compressor off through the internal relay if the oil level remains too low after an extended period of time. Oil refilling continues after this.

When the oil level is sufficient the relay tightens, the compressor can start again.

The reactions are time delayed, to prevent unnecessary switching in response to temporary fluctuations in the oil level.

The INT280-60 Diagnose has its own monitoring system of the optical sensor. In the event of malfunctions or soiling, the relevant warning or error will be notified.

Selected parameters (see table of parameters) are adjustable via the Diagnose Port with the aid of the INTspector.

A connection to a Diagnose compressor protection unit can be created via the Diagnose Port. The oil level regulator optimises its behaviour using the data from the compressor protection unit, e.g. it only sounds an alarm for a lack of oil when the compressor is running.

The integrated LED signals the current status.

For operation in the specified manner, the supply voltage has to be on permanently on the INT280-60 Diagnose.

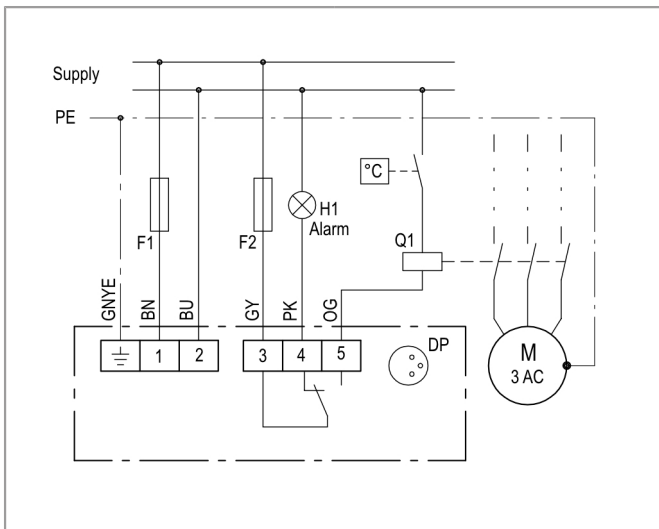

Wiring diagram

Order data

INT280-60 Diagnose	31 S 581 P031
Further product information	see www.kriwan.com

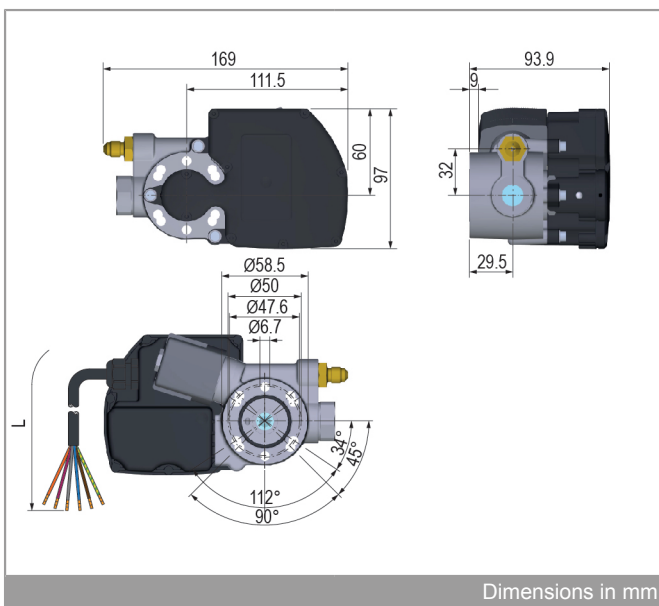

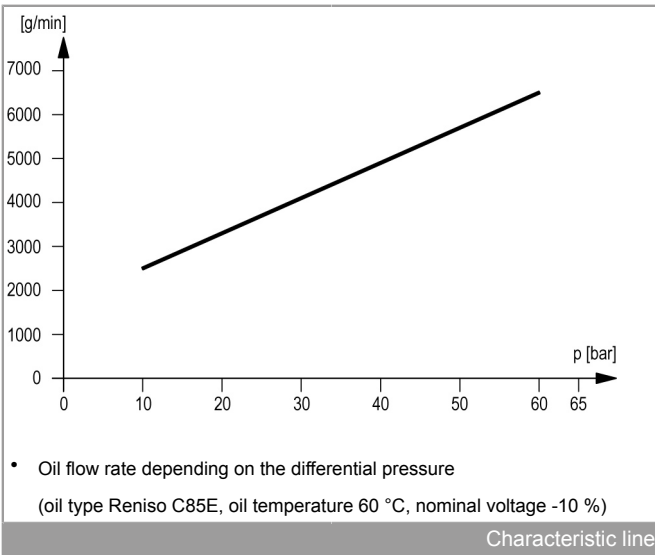

Dimensions in mm



 The mounting, maintenance and operation are to be carried out by an electrician. The valid European and national standards for connecting electrical equipment and cooling installations have to be observed.

Connection lines that extend from the terminal box have to feature at least a basic insulation.

 The user has to ensure that the connections are properly tight. The electrical connection needs to be carried out according to the wiring diagram.

 Prior to installation, ensure that the pressure in the refrigeration circuit is and stays equal to the atmospheric pressure.

 The voltage supply to the INT280-60 Diagnose must be switched off prior to installation/connection and the subsequent tasks.

Installation instruction

- Prior to installation, ensure that the O-ring at the connecting flange is seated properly.
- There must be no foreign objects in the oil infeed or outfeed area of the INT280-60 Diagnose.
- The device has to be mounted to the compressor horizontally. It can be rotated by 180°.
- Use matching washers for the flange fastening screws.
- Oil level regulator is pre-assembled in installation position.
- Manually screw in the screws.
- Afterwards tighten the screws alternating with a torque of 9Nm (M6, steel 8.8, dry).
- The electrical connection needs to be carried out according to the wiring diagram.
- For use at low temperatures, an oil sump heater has to be installed, to ensure trouble-free operation of the INT280-60 Diagnose.
- An oil filter has to be installed in the oil infeed line of the INT280-60 Diagnose, to prevent the solenoid valve seat from getting dirty.
- Before the refrigerating system is filled with refrigerant, the system and the connections of the INT280-60 Diagnose have to be checked for leaks.

Flash code

The KRIWAN flash code allows for a quick and easy status display and troubleshooting.

The flash code consists of a cyclical flash sequence (red / orange or green / orange). The current status can be determined from the number of pulsing flashes.

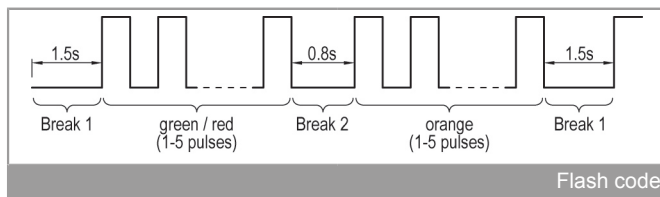

Overview flash code

Green lit	Oil level OK
Green flashing	Oil level too low, fill
Green/Orange flashing	Warning, see below for description
Red/Orange flashing	Error, compressor is switched off; for description see table below

Warning

1st flashing sequence (LED green)	2nd flashing sequence (LED orange)	Description
1	2	Oil level monitoring: Soiled optics, stage 1
2	1	General: Low supply voltage
2	2	General: Unexpected filling behaviour identified

Error

1st flashing sequence (LED red)	2nd flashing sequence (LED orange)	Description
1	1	Oil level monitoring: Oil level too low
1	2	Oil level monitoring: Soiled optics, stage 2
1	3	Oil level monitoring: Internal sensor fault
2	1	General: Supply voltage too low
2	3	General: Internal alarm
2	4	General: External alarm

Technical specifications

Supply voltage	AC 50/60 Hz 24 V ±10 % 25 VA
Permissible ambient temperature T _A	-30...+60 °C
Permitted rel. humidity	10-95 % r. h. no condensation
Medium temperature	-30...+100 °C
Operating pressure	-1...+60 bar
Test pressure	90 bar
Differential pressure	
– AC 50 Hz	1-55 bar
– AC 60 Hz	1-50 bar
Relay	
– Contact	AC 240 V 2,5 A C300 at least AC/DC 24 V 20 mA
– Mechanical service life	Approx. 1 million switching cycles
Interface	Diagnose Port (DP)
Protection class acc. to EN 60529	IP65 ((DP cable or cover has to be installed)
Supply	
– electrical	Cable 6xAWG-18, L=1 m
– Oil	7/16"-20 UNF
Mounting	Flange (3-/4-hole)
Housing material	Aluminium PA glass-fibre-reinforced
Flow rate through valve	1 l/min (water 20 °C, 1 bar differential pressure)
Permitted oils	Mineral and ester oils without additives
Permitted refrigerants	Non-corrosive, non-flammable
Mounting position	Horizontal (rotatable by 180°), ±2°
Dimensions	See dimensions in mm
Weight	Approx. 1400 g
Check base	EN 61000-6-2, EN 61000-6-3 EN 61010-1 Overvoltage category II Pollution level 2

Table of parameters

Parameter name	Setting range		Default	Unit	Individual settings
	Min	Max			
Filling cycle type	Fixed	Adaptive	Fixed		
Filling time	3	120	10	s	
Manual filling	0	120	0	s	
Break time	20	200	20	%	
Overfill time	0	120	2	s	
Set number of filling periods	1	10	2		
Oil deficiency alarm monitoring	when compressor is running	always	when compressor is running		
Oil deficiency alarm delay	10	600	120	s	
Alarm delay overfilling	0	Active	Deactivated	s	
External alarm via DP bus	Deactivated	Active	Active		
Operating recognition via DP bus	Deactivated	Active	Active		
Behaviour monitoring	Deactivated	Active	Active		
Filling cycle time overrun coefficient	1.1	50.0	50.0		
Time overrun without filling coefficient	1.1	50.0	50.0		
Soiling stage 2	Warning	Alarm	Alarm		

KRIWAN Industrie-Elektronik GmbH

Allmand 11

74670 Forchtenberg phone: (+49) 7947 822 0 info@kriwan.com

Deutschland fax: (+49) 7947 1288 www.kriwan.com

